

HSEUREG07201

720W Programmable DC Lab Power Supply, TS35mm DIN-Rail

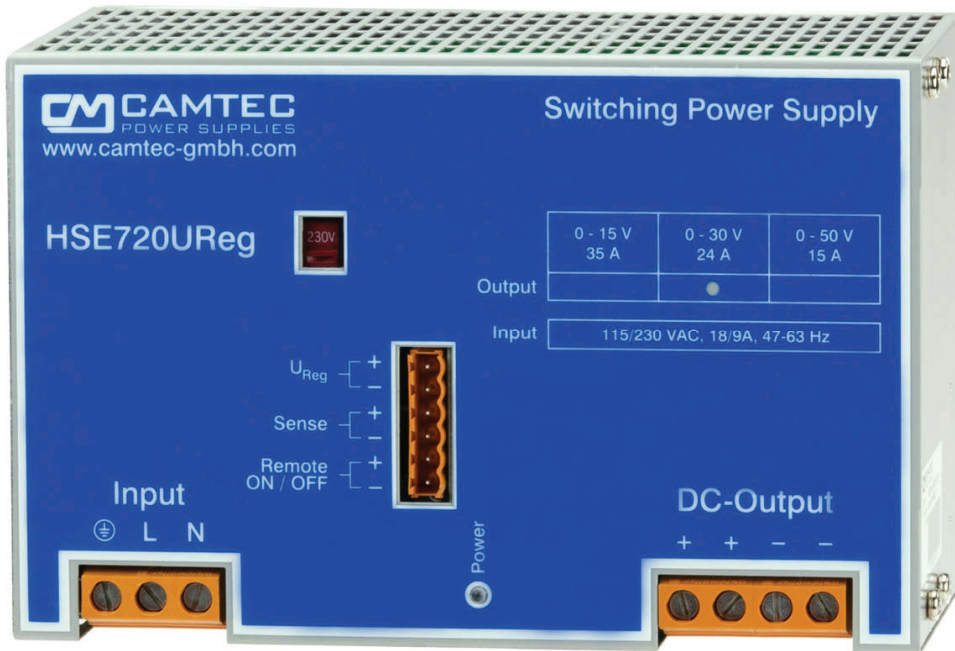

Specification:

- Save 0–Umax programming
- Multi interface 0-10V & 0-20mA
- Sense & Shutdown (remote ON/OFF)
- N+1 parallel operation
- Natural Convection
- Precise dynamic response on load change
- Designed for long life under full stress
- Strong input filters
- High reliability, shock & vibration proof
- EMC meets CE norm class B
- Over Voltage and continuous short circuit protection
- Double terminals 4x AWG20 – AWG6 (0,5 – 16mm²)

Models	Programmable Voltage
HSEUREG07201.015T	0-15Vdc / 35A
HSEUREG07201.030T	0-30Vdc / 24A
HSEUREG07201.050T	0-50Vdc / 15A
HSEUREG07201.090T	0-90Vdc / 8.0A
HSEUREG07201.130T	0-130Vdc / 5.5A
HSEUREG07201.180T	0-180Vdc / 4.0A



Powerbox Australia Pty Ltd Sydney (Head Office)
4 Beaumont Rd Mount Kuring Gai NSW 2080 AUSTRALIA
1800 251 380 sales@powerbox.com.au www.powerbox.com.au

Powerbox Pacific Ltd Auckland
1a Henry Rose Place Albany Auckland 0632 NEW ZEALAND
09 4158 320 sales@powerbox.co.nz www.powerbox.co.nz

(Subject to alterations. This product is not designed to be used in applications such as life support systems wherein a failure or malfunction could result in injury or death)

Version 1.0 10/2018

Technical Concept

The Camtec HSEUREG models are high-precision lab power supplies „Made in Germany“. These power supplies are designed for power systems in the testing automation and for industrial use.

For more than 20 years the Camtec Power Supplies manufactures high-end switch mode power supplies in Germany. A field breakdown of below 4 sigma over a 10 years period under review approves our ambitious quality concept. Each manufactured Camtec product passes several 100% random tests for each detailed function and a full-load Burn-In test.

Although it is not required from the safety norms our production applies a routine safety test to each manufactured device, even if it is an extra low-voltage model. The components in the assembled device pass stress aging to achieve an even level and to prevent from delayed failures. Our internal product engineering guidelines provide a clear target: Camtec product reputation must say „mount and forget“. Quality is never a mere promise for our team.

The HSEUREG laboratory power supplies provide low noise and ripple, a very quick programming, and an absolutely precise setting at high load changes. With an efficiency up to 90% the devices are highly energy efficient.

Equipped with high-end capacitors of outstanding lifetime our power supplies guarantee a very long and reliable operation time. The circuit design of the HSEUREG Series allows cope playing with complex loads. The internal protection circuits protect the power supply and the connected system, even in exceptional situations. The HSEUREG series is protected from high transients by strong filters with high energy efficiency. All inputs and outputs and the interface are electrically isolated. The design specifications call for the highest standards of safety and interference suppression. The device was developed in accordance with the requirements of IEC/CSA/UL60950-1 and the EMC standards EN55022 Class B.

The 480W and 720W models provide natural convection. The 1kW models use a forced air cooling system with a two stages fan. In selecting the fan, as with all our power supplies, in our opinion we use with the German manufacturer EBM Papst the highest quality and most reliable devices in the world market.

Design Conception

The HSEUREG power supply series realizes high programmable power in a space-saving housing. Latest generation electrical devices relate to the high reliability of all CAMTEC products. The CAMTEC philosophy is, to employ 125°C low ESR ultra long life capacitors where expedient to achieve a superior lifetime of the product. The HSEUREG power supply is made for high reliable and demanding industrial applications like galvanic systems, professional DC-drives, and complex test benches

Programming Performance

THE HSEUREG power supply is very equal to a typical laboratory power supply – just without its displays. It is designed for automated industrial test benches in a 24/7 operation. The HSEUREG provides save and precise down to zero voltage programming. The product is equipped with a multi-functional interface. Thus the interface can be operated with either 0-10Vdc/20mA or with 0-20mA programming. The burden is 500Ω to ensure interference free operation with high impedance controller interfaces. The device features a small latency and a quick all rise time that leads to typical 15ms from zero to Umax programming.

Galvanic Isolation

The power supply is galvanic isolated between the input and the output. All features like the Power Good Relay are connected to the DC power outputs.

Thermal shutdown

The HSEUREG is featured with a thermal overload shut down and auto recovery behaviour.

Over Voltage Protection

Ticker mode and auto recovery

Short Circuit Protection

A continuous short circuit does not cause damage to the power supply. The HSEUREG delivers constant current and zero output voltage. It recovers automatically after the short circuit is released.

Open Circuit Protection

The HSEUREG series is continuously open circuit protected. The device delivers a stable output voltage and no current. If a load is immediately connected to the device, the power supply stabilizes within 1ms. It does not overshoot the output voltage.

Power Up Ramp

The devices has a soft start ramp when powering up. The device does not either overshoot the voltage nor does the output flutter – independent if a load is connected or not.

Technical Table

AC Input	90..132Vac / 184..265Vac , 47...63Hz , 250...375Vdc					
AC Input Rating	115Vac<13.2A 230Vac<6.5A 250Vdc<3.6A 375Vdc<2.4A					
Rated DC Voltage	0-15V	0-30V	0-50V	0-90V	0-130V	0-180V
Overvoltage Protection	18Vdc	35Vdc	59Vdc	105Vdc	150Vdc	210Vdc
Rated DC Current	35.0A	24.0A	15.0A	8.0A	5.5A	4.0A
Power Boost -25...+60°C <1min.	38.5A	26.4A	16.5A	8.8A	6.1A	4.4A
Max. DC Current +70°C	26.3A	18.0A	11.3A	6.0A	4.1A	3.0A
Ripple Peak 230Vac 20MHz	40mVpp	50mVpp	100mVpp	150mVpp	200mVpp	300mVpp
Sense function	Compensation 2V per lead load, protective electrical separation ≤60Vdc					
Remote Shutdown	protective electrical separation ≤60Vdc					
Analogue Interface	see table, protective electrical separation ≤60Vdc, working impedance = 500Ω					
Pmax (average)	720W continuous and ca. 792-924W bower boost for max. 60s (see Power Boost above)					
Derating	+60°C...+70°C 2.5%/°C					
Accuracy	< ± 1.5% Interface					
Latency Interface	15ms including signal latency for 0-Umax programming					
Load regulation	< ± 0.2% 0-100%					
Response Load Change	<1ms 10-100%, 100-10%					
Base Load	None					
Efficiency 230Vac	90% typical					
Short Circuit Protection	Continuous					
Idling-proof	Yes					
Temperature Control	Yes, thermal shutdown with auto recovery (+70°C, metering distance 10mm)					
Hold Up Time	> 40ms 230Vac					
Inrush Current	< 162A (230Vac) @25°C					
MCB (Miniature Circuit Breaker)	16A curve C (need to connect 2 units to a single 16A curve-B MCB? use our ESB101.33 limiter!)					
Soft Start	100ms typical					
Cooling	Natural convection					
Ambient Operating Temp.	- 25°C...+70°C					
Ambient Storage Temp.	- 40°C...+85°C					
Environment	Humidity 95% non-condensing @ 25°C, climate class. 3k3, pollution rate II					
ROHS	2011/65/EG confirmed					
REACH	EG No. 1907/2006 confirmed					
EMI	EN55022 class B					
EMS	EN61000-6-2,3					
Safety	EN60950-1, EN60204-1					
Safety class 1(A)	VDE0805, VDE0100					
Isolation Path	> 8mm					
Input / Output	Galvanic insulated					
Meantime By Failure (MTBF)	400000h (IEC61709)					
Dimensions (HxWxD)	130x200x114,5mm					
Weight	3000g					
Screw Terminals (In/Out)	AWG20...AWG6 , 0.5...16mm ² (76A @ 40°C)					

Manual und Technical Details

Programming Time Vout [ms]

Model HSEUREG07201	.018	.030	.060	.090	.130	.180
Rise Time 0-100%, 10/100% Last, [ms] typ.	15/15	15/15	15/15	15/15	15/15	15/15
Slew Rate 90-10%, 10/100% Last, [ms] typ.	36/3.6	104/10.4	49/4.9	57/5.7	53/5.3	100/10
Output Capacity, [mF] typ.	10.36	10.36	1.85	0.64	0.28	0.28
Interface Latency	15ms including signal latency for 0-Umax programming					

Analog Interface

Pin	Name	Type	Function	Signal	Remarks
1	Ureg +	Input	Voltage Programming	0-10Vdc/20mA & 0-20mA multi-functional interface	500 Ω working resistance with voltage programming
2	Ureg -	Input			
3	Sense +	Input	Sense Control	none	Compensation max. 2V per load line
4	Sense -	Input			
5	Remote +	Output	External Shutdown Remote ON/OFF	Open Collector or Switch	Voltage drop <1V with typical 2.3mA
6	Remote -	Output			

Programming Interface Ureg

The standard programming of the HSEUREG Series is an analog interface. The output voltage is linearly proportional to the adjusted analog control signal. If the control signal 0V applies the power supply delivers 0V at the output. The power supply is already working from 0V output voltage and low load with high precision.

The analog inputs are non-floating. The mass is connected to the DC negative output. The burden of the interface is 500Ω. The latency to full compensation of V/C on the interface from 0-100% is 15ms for all HSEUREG models.

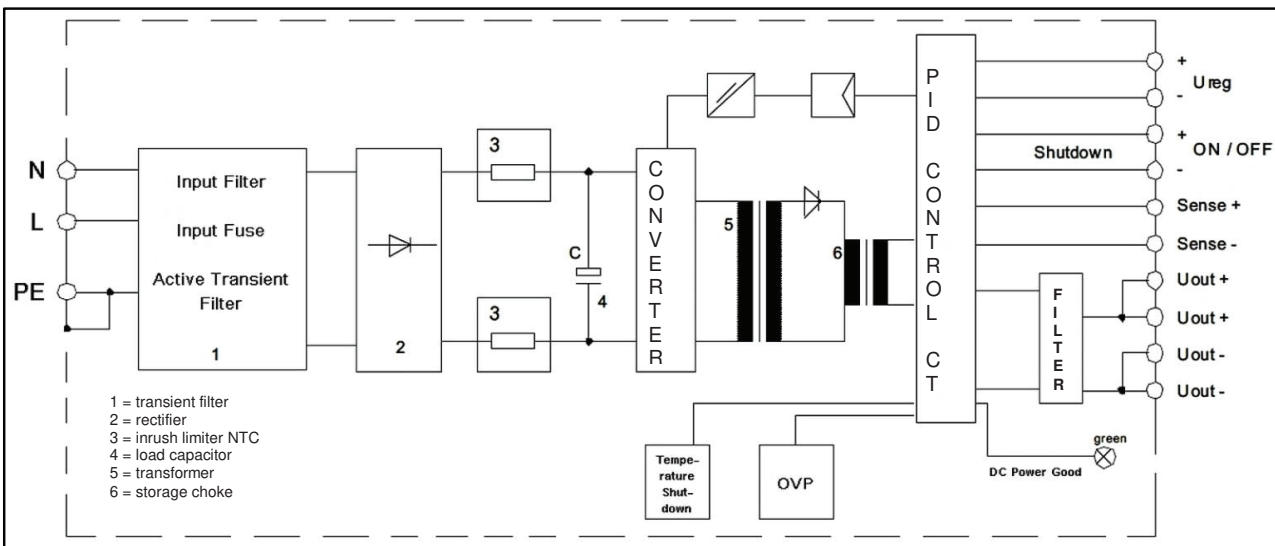
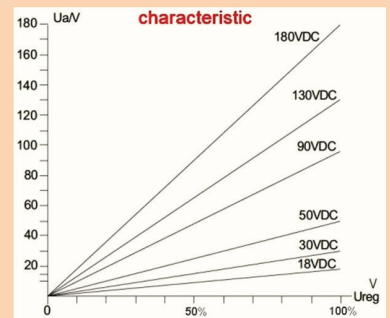

Compensation of Load Line Drop Voltage (Sense +/-), standard operation mode

The HSEUREG power supply has a Sense Mode to compensate for the voltage drop over long load lines. The compensation amounts to a maximum of 2V per load line. Under certain circumstances, it can be expected to apply fairly more complicated external interference suppression.

Sense operation:

Connect the sense lines directly to the load. Pay attention to the polarity of plus and minus of the load to prevent damage to the power supply. To avoid interference, twist the sense lines. In order to reduce inductive effects, we recommend that the load lines position is close to each other. In order to supply a pulsating load, the use of an electrolytic capacitor and a ceramic capacitor has proved. The internal Over Voltage Protection (OVP) of the power supply controls the DC power directly to the DC output terminals. In case of an error the OVP acts automatically (see OVP values corresponding technical table page 3).

The sense terminals are directly connected to the power outputs.

Remote Sensing Schematics

Although the HSEUREG sense block is more simple, it applies to the below schematics. Please note that the HSEUREG has no AUX connection feature and that the sense block has only +/- connections. We recommend twisted sense lines.

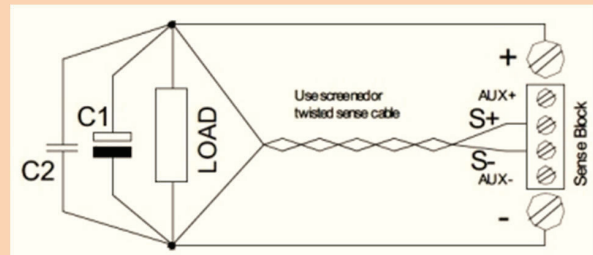

Compensation of Load Line Drop Voltage (Sense +/-), battery charger operation mode

Remote Sensing as a battery charger

If the HSEUREG power supply unit is used as a battery charger, it is recommended to refrain from sensing. It can lead to severe damage to the power supply, if the polarity of the sense line is confused (field experience: such error often occurs when system service is required, e.g. when the batteries are changed). If it is absolutely necessary to use sensing, proceed as described in the figure below. Proven approaches are 250mA for the fuses and 3...5A load capacity of diodes.

Although the HSEUREG sense block is more simple, it applies to the below schematics. Please note that the HSEUREG has no AUX connection feature and that the sense block has only +/- connections. We recommend twisted sense lines.

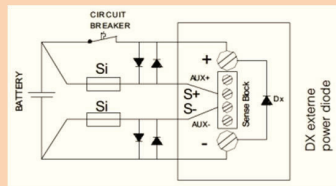
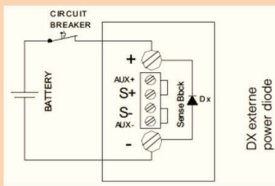

External Shutdown (SD)

The power supply is set to the Shutdown mode, when the control input is either shorted via a relay contact, a switch contact or an NPN transistor with open collector (voltage drop <1V, current typ. 2,3mA).

If the shutdown repeats the power supply starts with a typical delay of 250ms.

Using the soft start the current and the voltage rises within 100ms continuously to the default set values. Note that the input is not floating. The common ground is internally connected to the Sense. The sense is connected to DC-minus output.

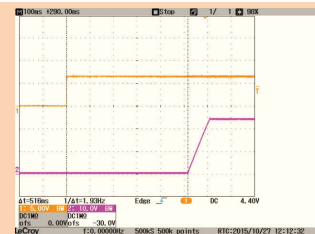

Temperature Derating

The maximum ambient temperature during operation is + 70°C. If the over temperature protection is activated, the power supply is switched off.

The measuring point is 10mm outside the power supply. The power supply unit starts automatically when it has cooled down.

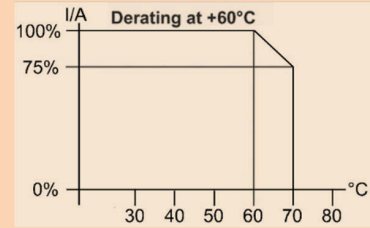

Series Operation

Two or more units of the same model and output voltage can be operated up to a total voltage of 240Vdc in series. Due to the dielectric strength of the internal components used, only the models with an output voltage of 90Vdc and later are approved for series operation. Other power supplies are not approved for series operation above 60Vdc.

If the units are remotely controlled via the analog interface it is compulsory to use a potential-free control voltage!

Parallel Operation & N+1 Decoupling

In order to increase the overall power of the power supply, two or more devices of the same model with the same output voltage may be operated in parallel. We recommend using a busbar for the DC power connector. Make sure that the cable lengths and cable cross-sections of all power supplies to the busbar or to the star point are identical. If you want to use the sensing function, connect it also to the star point or busbar. To avoid measurement errors, select the line length from the neutral point or from the busbar to the load as short as possible and use the maximum possible conductor cross-section.

The HSEUREG models have no internal O-ring diode, to operate the devices N+1 redundant.

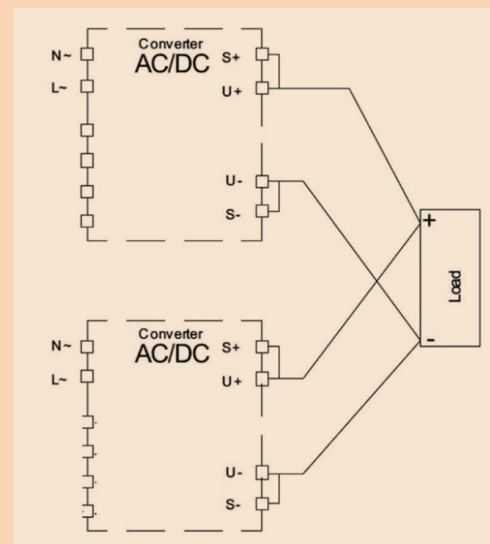

Isolating Transformer 1:1 ADTW201 for galvanic isolation (external optional device)

The isolating transformer is used to galvanic isolate impressed current. The device is self-powered. The input to output ratio is 1:1. We recommend to use the isolation transformer for all units above 60Vdc output voltage until the system integrator did not approve other arrangement to meet national safety requirements.

Coating Option

We offer the USEureg-series with optional coating. It is to be used in e.g. dusty, dirty, high humidity, or in awaiting quick temperature changes. Short circuit and corrosion at print board lines and at solder points can be prevented. The coat itself is a transparent acrylic resin. Peters SL 1306 N-FLZ (transparent) IEC60216-1 2001, IPC-CC-830B, UL listed as permanent coating FileNo.: E80315 , UL94V-0

Electrical Safety (Factory-Test / Fieldtest Owner)

Type Test	T	A	B	C ¹⁾	D
60s	2500Vac	3000Vac	500Vdc	3000Vac	
5s	2000Vac	2000Vac	500Vdc	1000Vdc	
2s	2000Vac	2000Vac	500Vdc	1000Vdc	

¹⁾ ≥60Vdc= 2400Vdc

Type and factory-test are reserved to the manufacturer. While repating damage can happen to the power supply unit. For the field-test (owner-test) follow the below instruction:

- Use suitable test equipment, raising the voltage slowly
- Short circuit L1 and N, and all the DC output terminals.
- Use only test voltages of 50/60Hz. The outputs are unearthed and therefore they have no resistance to GND/PE.
- If the residual voltage is ≥60Vdc, observe the safety standards. Use only specially insulated screwdriver to trim the Ua/Ia.

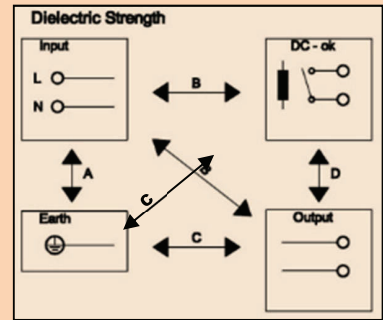

Terminal Connects:

AC Main Input
 GND common
 N - wire
 L - wire

DC Mains Outputs
 DC + voltage
 DC + voltage
 DC - voltage
 DC - voltage

Inputs/Outputs

Ureg = programmable voltage input
 Ireg = programmable current input
 SD = shut down input
 Sense = Sensing (compensation: 2V)

Mechanics & Installation Instruction of the HSEUreg

Stable metal/aluminium housing IP20. To allow adequate convection, a free air space of 50mm (top/bottom) and 10mm (sidewalls) is required; and for active devices 15mm space from the sidewalls. For proper air convection it is necessary to install the HSEUreg. One can use the DIN-Rail installation (equiped standard) with our patented 35mm DIN-Rail bracket according to EN60275. It is easy to mount/dismount while snapping it onto the 35mm DIN-Rail - no tools necessary.

It is not allowed to install the HSEUREG in other mounting direction then below drawings.

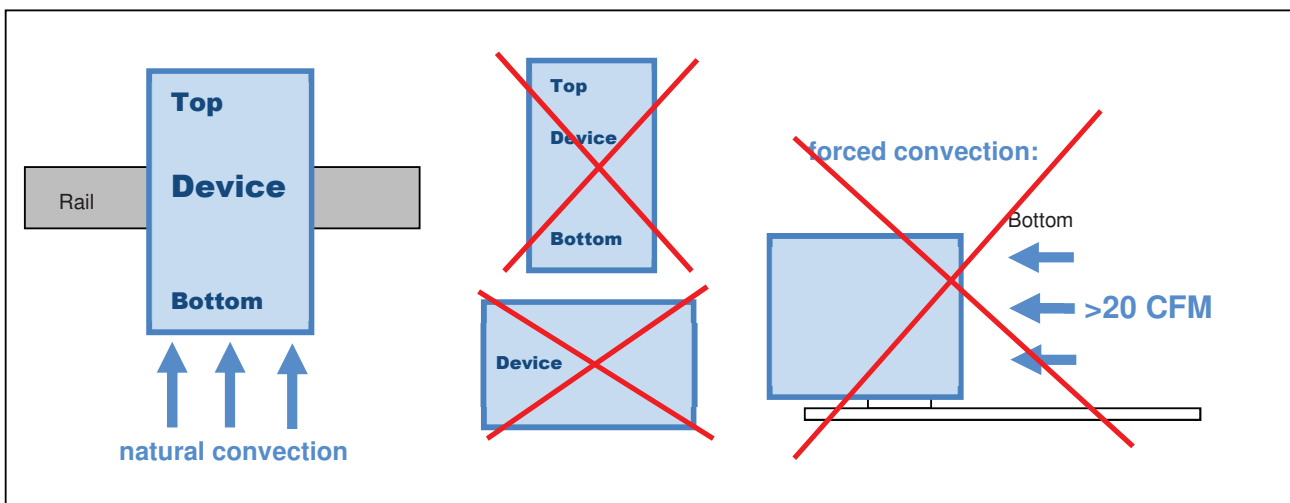
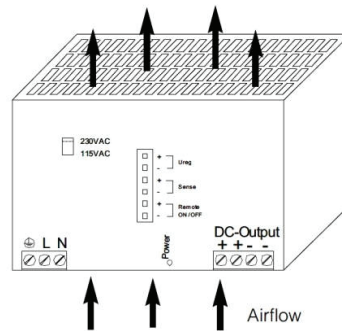
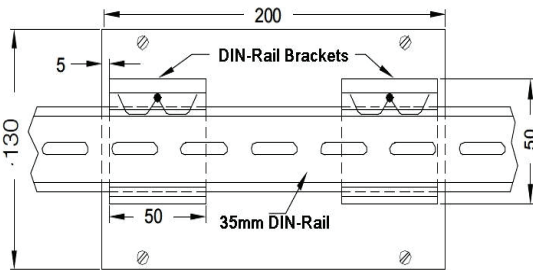

Mounting Instruction

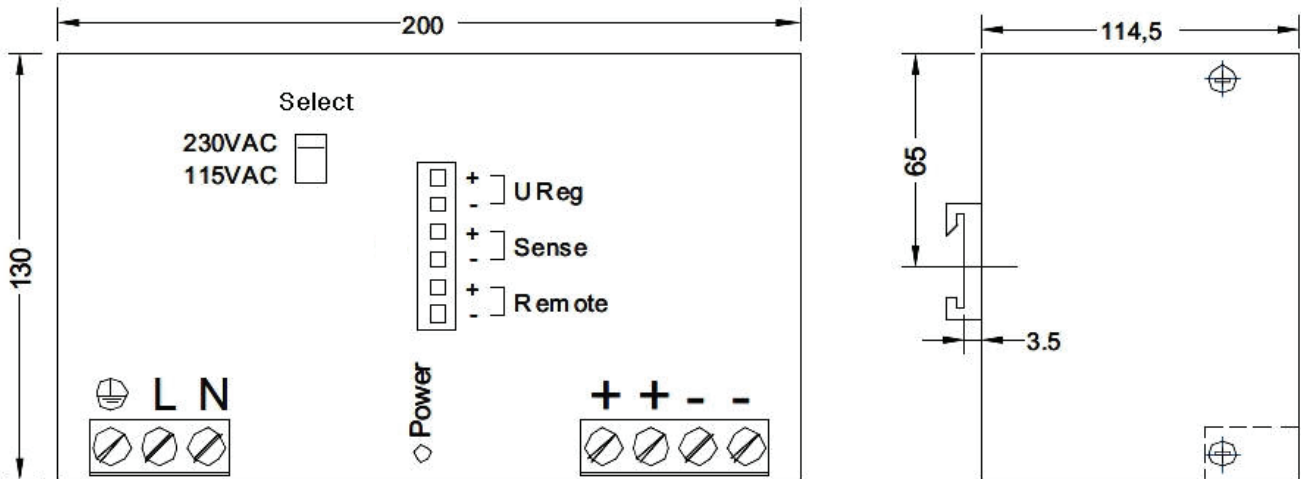

Ordering Information

Output	Type (DIN-Rail standard)	Part Number	Remarks
0-15V	HSEUreg07201.015T	3041052001CA	
0-30V	HSEUreg07201.030T	3041052002CA	
0-50V	HSEUreg07201.050T	3041052003CA	
0-90V	HSEUreg07201.090T	3041052004CA	
0-130V	HSEUreg07201.130T	3041052005CA	
0-180V	HSEUreg07201.180T	3041052006CA	
Option	Screw Terminal Plug	3520037 for the pack	Optional Plug for the interface, 2 poles LS5,08 180°cabling, (10pcs each pack)
Option	ADTW201	3041090001CA	Optional DC-repeater 1:1 with no losses for save interface separation >60Vdc
Option	Protective Coating	-	Ask for technical support and personal quote from your retailer

Safety regulations: Please read these instructions completely before using the equipment. Keep these instructions on to hand. The device may only be operated by trained specialist staff.

Installation:

- 1) The device is designed for devices and systems that meet the standard requirements for hazardous voltages, power and fire prevention.
- 2.) Installation and service only by trained persons. The AC power must be switched off. The work is to be labeled; accidental reconnection of the system must be prevented.
- 3.) Opening the device, its modification, loosening bolts or operation outside the specified herein specification or in an unsuitable environment, has the immediate loss of warranty to follow. We disclaim any responsibility for any resulting damage to persons or things.
- 4.) Note: The device must not be operated without an upstream circuit breaker (CB). We recommend the use of C-Type 16A. It is prohibited to use the unit without PE. It may be necessary upstream device has a power switch.

Warning:

- Non-compliance can result in fire and serious injury or death.**
1. Operate the appliance without PE connection.
 2. Before connecting the device to the AC network, make wires free of voltage and assure accidently switch on.
 3. Allow neat and professional cabling.
 4. Never open nor try to repair the unit. Inside are dangerous voltages that can acause electrical shock hazard.
 5. Avoid metal pieces or other cunductive material to fall into the item
 6. Do not operate the device in damp or wet conditions
 7. Do not operate the unit under EX-conditions

All parameters base on 15 minutes run-in @ full load / 25°C / 230Vac 50/60Hz, as otherwise stated.